

LPS - Roadway

Project Name	Type
Catalog Number	

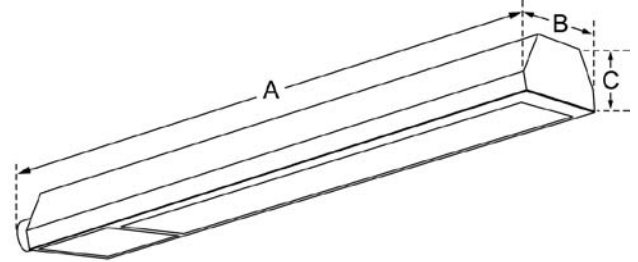

Dimensional Drawings



Fixture	A	B	C	Max. Watts	Lbs
RDW-1	34"	9½"	5½"	55w	55
RDW-2	39"	9½"	5½"	90w	60
RDW-3	63"	9½"	5½"	180w	75

The **Roadway** series is designed to maximize the benefits of Low Pressure Sodium light sources with unmatched lumens per watt, while eliminating glare with IES full cutoff optics and providing an easy-to-maintain roadway luminaire that meets the most stringent municipal requirements.

Roadway is available in three sizes for 55, 90, 135, and 180 watt lamps, with two types of light distribution patterns. Mounting and maintenance are both user friendly. A cast aluminum arm adaptor attaches the luminaire to the mast arm. Tool-less latches open the fixture housing for easy access to the lamp and the ballast which can be mounted on an removable power tray.

A durable thermoset polyester powder coat textured grey finish is supplied as standard and guaranteed for a full 5 years. Computerized precision machinery and quality materials ensure manufacturing to the highest industry standards.

Low Pressure Sodium lighting is the community standard for a number of areas where observatories are located. The International Dark Sky community also favors the use of this light source for all types of outdoor lighting. Street lighting, roadways, bridges, and general area lighting can all utilize the **Roadway** fixture to minimize light pollution.

Model	Optics	Wattage	Source	Voltage	Mounting	Finish	Options
RDW-1	Type II (T2)	55 (55)	LPS (L)	120 (1)	Mast Arm Fitter *Slips over 2½" O.D. (MAF)	Grey (GY)	<u>Photocell & Receptacle</u> *Specify voltage (PCR120) (PCR208) (PCR240) (PCR277) (PCR480)
	Type III (T3)			208 (2)			
RDW-2		90 (90)		240 (3)			<u>Button Type Photocell</u> *Specify voltage (PC120) (PC208) (PC240) (PC277)
				277 (4)			Ballast Bolted to Door (BBD)
				480 (5)			<u>Removable Ballast Tray</u> *Comes standard with Quick Disconnects, Terminal Block and Photo Receptacle with Shorting Cap. (RBT)
RDW-3		135 (135) 180 (180)		M-Tap (6)			<u>Fusing</u> *Specify voltage Single in-line fuse (SF120) (SF277) Double in-line fuse (DF208) (DF240) (DF480)
				347 (8)	*Multi-Tap ballast wired at 277v unless specified		
							Ballasts come standard 135/180w, 90w and 35/55w.
			L - Low Pressure Sodium				

For more detailed information on mounting, wiring, or installation instructions, please consult factory. Note that if Poles are not ordered with fixtures, please specify the mounting requirements. This document contains proprietary information of Visionaire Lighting, LLC. Any use of this information requires the written approval of Visionaire Lighting, LLC. In keeping with our TQM policy of continuous improvement, Visionaire reserves the right to change any specifications contained herein without prior notice.

Housing

- **Roadway** is precision CNC sheared and formed aluminum. Door assembly offers integral latches for tool-less access. Three housing sizes for different wattages.
- All hardware is rust resistant stainless steel.

Lens and Door Assembly

- Hinged door frame is fully gasketed. A one piece extruded silicone gasket seals the door frame against the housing.
- The lens is clear, impact resistant Lexan, secured with galvanized lens retainers, and sealed with form fitting silicone gasketing.

Optical System

- Reflector is precision CNC cut and bent, multi-faceted, segmented, 95% reflective aluminum reflector for IES Type II and III light distribution.

Quali-Guard® Finish

- The finish is a Quali-Guard® textured, chemically pretreated through a multiple stage washer, electrostatically applied, thermoset polyester powder coat finish, with a minimum of 3-5 millimeter thickness. Finish is oven baked at 400 degrees Fahrenheit to promote maximum adherence and finish hardness. All finishes are available in standard and custom colors.
- Finish is guaranteed for two (2) years.

Mounting

- Fixture fits over a 2 $\frac{3}{8}$ inch fitter, and comes standard with ring gasket (bug and bird guard) inside the mast arm fitter and utilizes a 6 $\frac{3}{8}$ inch stainless steel hex head set bolts to secure the fixture to the mast arm.

Electrical Assembly

- All ballasts are premium grade HPF high reactance auto transformer, factory wired and tapped to voltage requirement.
- LPS lamps from 55 through 180 watts, providing high lumens per watt, superior energy efficiency, and quick restrike.
- Removable ballast tray option comes standard with Quick Disconnects, terminal block, photo receptacle, and shorting cap.

Options

- Removable ballast tray
- Fusing
- Twistlock photocell & receptacle
- Button Style Photocell
- Ballast bolted to door

Please consult factory for custom options.

Listings

- Roadway is  listed, suitable for wet locations.
- Dark Sky Friendly® certified by the International Dark Sky Association.

Isolux Curves

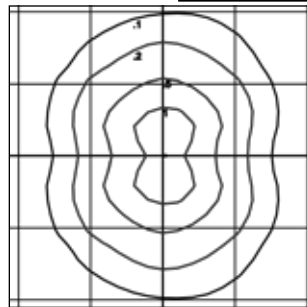



Size One

Type III 90w
LPS Secular Reflector
33ft Mounting Height
Flat Acrylic Lens
1 Block=33ft

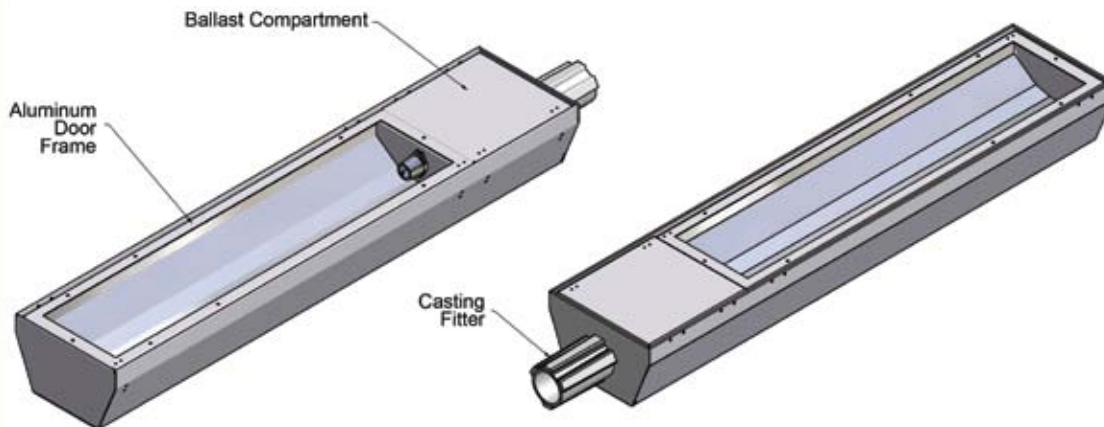
Mounting Detail



EPA Data

Fixture with Arm			
RDW-1	1.3	1.7	2.6
RDW-2	1.5	1.9	3.0
RDW-3	2.4	2.8	4.8