

Project Name	Type
Catalog Number	

Caribbean

AREA



Dimensional Drawings

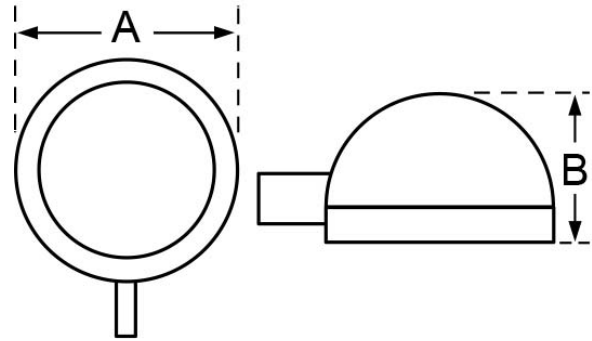

Fixture	A	B	Max. Watts	Lbs
CAR-1	18"	10"	175w Flat Glass (Convex Optional)	35
CAR-2	22"	12"	400w Convex Glass Only	50

The **Caribbean** series features the most advanced lighting reflector system available today. Vision™ is a patented, revolutionary new reflector system unlike any other. The flat lens, vertical lamp, IES full cutoff luminaire is certified by the International Dark Sky Association to restrict light trespass, glare and light pollution for neighborhood-friendly outdoor lighting (convex glass lens is available when required).

The housing features a distinctive dome shape with a complementary circular decorative reveal. Durable polyester powder coat finish is available in a wide array of architectural colors to enhance the design application. Computerized precision machinery and quality materials ensure manufacturing to the highest industry standards.

The **Caribbean** series is offered in two enclosure sizes and four IES distribution patterns. The Vision™ Reflector System allows for the use of fewer fixtures and poles with wider spacing providing substantial equipment, installation and energy cost savings.

The **Caribbean** is an excellent choice for shopping centers, parking lots and general area lighting. A wide selection of light sources from 100 watts thru 400 watts is offered in High Pressure Sodium and Pulse Start Metal Halide lamp which provides excellent efficiency, lumen maintenance and color.

Model	Optics	Wattage	Source	Voltage	Mounting	Finish	Options
CAR-1 Flat Glass (Convex Glass Optional)	Type II (T2)	100 (100)	PS, HPS	120	Bolt-On Arm 6" (BOA6)	Bronze (BZ)	Photocell & Receptacle <small>*Specify voltage</small> (PCR120) (PCR208) (PCR240) (PCR277) (PCR480) Photo Receptacle (PER) <small>*With shorting cap</small> Button Type Photocell <small>*Specify voltage</small> (PC120) (PC208) (PC240) (PC277) Quartz Restrike (QR) Fusing <small>*Specify voltage</small> Single in-line fuse (SF120) (SF277) Double in-line fuse (DF208) (DF480) (DF240) House Side Light Shield (LS) Light Trespass Eliminator <small>*Internal light shield: CAR-2 only</small> (LTE) Convex Glass Lens (VLCG) Round Pole Plate Adaptor (RPP) Cast Wall Plate (BAWP)
		150 (150)	PS, HPS	208		Black (BK)	
	175 (175)	PS (P) (S)	240 (3)	Bolt-On Arm 10" (BOA10)	White (WH)		
			277 (4)		Forest Green (GN)		
CAR-2 Flat Glass (Convex Glass Optional)	Type IV (T4)	250 (250)	PS, HPS	480 (5)	Spider Mount (SM) <small>*Fits 2 1/4"-3" O.D.</small>	Grey (GY)	
	Type V (T5)	320 (320)	PS	M-Tap (6)	Wall Mount (WM) <small>*Cast Wall Plate (BAWP) to</small>	Silver Metallic (SL)	
		400 (400) <small>*Reduced Envelope Lamp on 400w</small>	PS, HPS (P) (S) <small>*Consult factory for Induction</small>	<small>*Multi-Tap ballast wired at 277v unless specified</small>		Custom Color (CC)	
			347 (8)	Unless specified, BOA6 will be supplied for S1 & D180 mounting. BOA10 supplied for all other mounting configurations. Round Pole Plate Adaptors (RPP) are to be ordered separately.			

For more detailed information on mounting, wiring, or installation instructions, please consult factory. Note that if Poles are not ordered with fixtures, please specify the mounting requirements. This document contains proprietary information of Visionaire Lighting, LLC. Any use of this information requires the written approval of Visionaire Lighting, LLC. In keeping with our TQM policy of continuous improvement, Visionaire reserves the right to change any specifications contained herein without prior notice.



19645 Rancho Way • Rancho Dominguez, CA • 90220
Tel: (310) 512-6480 • Fax: (310) 512-6486
www.visionairelighting.com

Housing

- All housings are one piece, spun aluminum, designed and engineered for a weathertight seal. Caribbean housings display a decorative reveal to give the luminaires a distinct appearance. All external hardware is stainless steel.

Lens and Door Assembly

- Door assembly is precision spun, one piece, corrosion resistant aluminum with captive stainless steel fasteners.
- The standard lens is a clear tempered flat glass, secured by galvanized lens retainers and sealed with silicone gasketing to provide complete weather and insect protection.
- An optional convex glass lens is available when required.

Vision™ Optical System

- Reflector is precision CNC cut and bent, multi-faceted, segmented, highly efficient, 95% reflective aluminum. Available in four distribution patterns.
- Tool-less reflector entry.

Quali-Guard® Finish

- The finish is Quali-Guard® textured, chemically pretreated through a multiple stage washer, electrostatically applied, thermoset polyester powder coat finish, with a minimum of 3-5 millimeter thickness. Finish is oven baked at 400 degrees Fahrenheit to promote maximum adherence and finish hardness. All finishes are available in standard and custom colors.
- Finish is guaranteed for two (2) years.

Mounting

- A rounded extruded aluminum, bolt-on-arm (BOA), with an in-pole nut plate, securing (2) ½ inch zinc running bolts with stainless steel hardware is standard. A Round Pole Plate Adaptor (RPP) is required for mounting to 3" - 5" Round Poles.

Electrical Assembly

- All ballasts are premium grade CWA or HPF regulating auto transformers. Ballast is capable of providing consistent lamp starting down to -20 degrees Fahrenheit. Available in:

- Pulse Start Metal Halide (PS)
- High Pressure Sodium (HPS)
- Induction (IND)

- Socket is glazed porcelain medium or mogul base with nickel plated contacts, rated at 4KV (5KV for 1000 watt) and 600V.

Options

- Twistlock photocell & receptacle
- Buttontype photocell
- Convex glass lens
- Round pole plate adaptor
- Fusing
- House side light shield
- Quartz restrrike
- Internal light trespass eliminator

Please consult factory for custom options.

Listings

- Caribbean is  listed, suitable for wet locations.
- Dark Sky Friendly® certified by the International Dark Sky Association (flat lens models only).

Isolux Curves

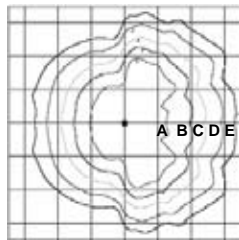

Type III 400w
PS VLFG 25ft
Mounting Height
Foot Candle Key:
A=2, B=1, C=.5,
D=.2, E=.1
1 Block=30ft

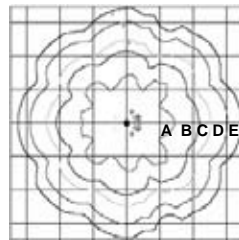

Type V 400w
PS VLFG 25ft
Mounting Height
Foot Candle Key:
A=2, B=1, C=.5,
D=.2, E=.1
1 Block=30ft

Bolt-On-Arm Detail

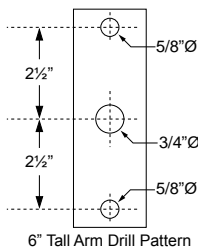
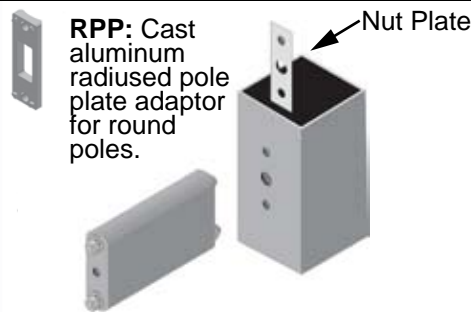

Cast Wall Plate

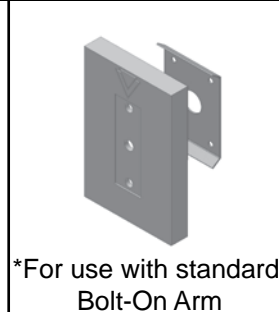

Spider Mount Detail

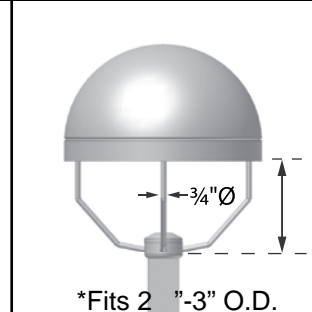







CAR-1 & 2: 6" or 10" Long x 6" Tall x 2" Wide

BAWP:
10" Tall x 6½" Wide

CAR-1: 8.89" Tall
CAR-2: 11.5" Tall

EPA Data

Fixture with Arm							
CAR-1	2.0	3.6	4.0	5.4	4.6	6.4	2.2
CAR-2	2.6	4.7	5.2	7.0	6.0	8.3	2.9